

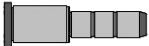









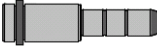









































# MOULDin Oy

N 01		1	N 074		26	N 145		37
N 02		6	N 08		28	N 155		37
N 03		11	N 09		30	N 16		38
N 035		Bronze 13	N 091		30	N 17		39
N 04		14	N 10		31	N 18		39
N 045		Bronze 15	N 101		31	N 19		40
N 046		Bronze 16	N 102		32	N 20		41
N 047		Bronze 16	N 11		32	N 21		42
N 048		Bronze 17	N 12		33	N 30		43
N 05		18	N 121		33	N 31		R 15,5 44
N 051		20	N 13		34	N 32		R 40 45
N 06		20	N 130		34	N 40		46
N 065		20	N 131		34	TXG		47
N 61		21	N 14		35	TPG		48
N 62		22	N 15		35	VP		49
N 63		22	N 135		36	SL		50
N 07		23	N 1305		36	Z08N		51
N 072		24	N 1315		36			52
								53
								54

## N 01

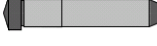
### Ohjaustappi

Tilaukoodi:

1 kpl N01 Ø 9/12/45

3 kpl N01 Ø10/12/45

Erikoismittoja tilauksesta

Raaka-aine: 1.7139 ca. 700HV

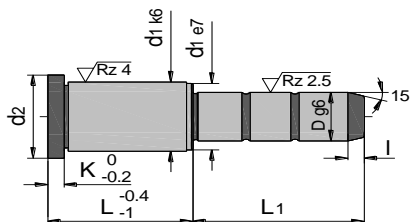

K	d1	d2	l	D	L	L1	€
3	14	16	4	9/10	12	45	5,01
3	14	16	4	9/10	17	20	3,26
						30	4,13
						35	4,60
3	14	16	4	9/10	22	25	4,13
						35	4,92
						55	6,75
3	14	16	4	9/10	27	25	4,52
						30	4,92
						35	5,40
						45	6,27
						50	6,75
3	14	16	4	9/10	36	25	5,16
						35	6,20
						45	6,75
3	14	16	4	9/10	46	30	6,75
						45	7,54
						55	8,82
						75	10,57
6	20	25	5	14/15	17	35	5,56
						55	7,69
						75	9,93
						95	11,85
6	20	25	5	14/15	22	20	4,52
						35	6,20
						40	6,66
						45	7,31
						50	7,46
						55	8,18
						65	9,38
						70	9,85
						90	11,67
						110	13,97

K	d1	d2	l	D	L	L1	€
6	20	25	5	14/15	27	20	5,08
						35	6,66
						40	7,23
						45	7,46
						55	8,73
						65	9,85
						85	11,67
						105	13,90
6	20	25	5	14/15	36	20	6,03
						35	7,46
						40	8,18
						45	8,66
						55	9,85
						65	10,72
						75	11,67
						95	13,90
6	20	25	5	14/15	46	20	7,23
						35	8,66
						45	9,85
						65	11,67
						85	13,90
						105	16,52
6	20	25	5	14/15	56	20	8,18
						35	9,85
						55	11,67
						75	13,90
						95	16,52
6	20	25	5	14/15	66	55	12,94
						65	13,90
						95	17,62
6	20	25	5	14/15	76	55	13,90
						95	18,66
6	20	25	5	14/15	86	55	16,36
						95	20,72
6	20	25	5	14/15	96	55	17,87
						95	22,13

## N 01 Ohjaustappi

Tilaukoodi

1 kpl N01 Ø18/22/20

3 kpl N01 Ø20/22/20

Erikoismittoja tilauksesta

Raaka-aine: 1.7139 ca. 700HV

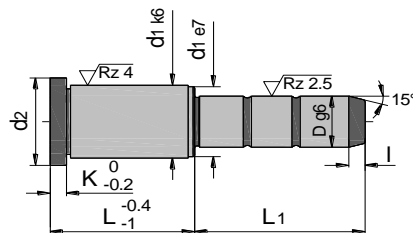

K	d1	d2	l	D	L	L1	€
6	26	31	7	18/20	22	20	5,16
						35	7,07
						40	7,63
						45	8,34
						50	8,97
						55	9,45
						60	10,08
						65	10,79
						70	11,51
						80	12,47
						85	13,34
						115	17,30
6	26	31	7	18/20	27	20	5,72
						35	7,63
						40	8,34
						45	8,97
						50	9,45
						55	10,08
						60	10,57
						65	11,51
						70	11,83
						80	13,34
						85	14,05
						105	16,43
125	18,98						
6	26	31	7	18/20	36	20	7,07
						35	8,97
						40	9,45
						45	10,08
						50	10,79
						55	11,51
						60	11,83
						65	12,47
						70	13,34
						75	14,05
						80	14,14
						95	16,43
115	18,98						
135	21,20						

K	d1	d2	l	D	L	L1	€
6	26	31	7	18/20	46	20	8,34
						45	11,51
						65	14,05
						85	16,43
						105	18,98
						135	22,39
						165	25,80
6	26	31	7	18/20	56	20	9,45
						35	11,51
						55	14,05
						75	16,43
						95	18,98
6	26	31	7	18/20	66	55	15,55
						75	17,87
						95	20,00
6	26	31	7	18/20	76	55	16,43
						75	18,98
						95	21,20
6	26	31	7	18/20	86	55	17,87
						75	20,00
						95	22,39
6	26	31	7	18/20	96	55	18,98
						95	23,66
6	26	31	7	18/20	116	115	28,19
6	30	35	7	22/24	27	25	6,27
						45	9,92
						50	10,79
						60	12,71
						65	13,58
						70	14,22
						80	15,55
						85	16,12
						105	19,21
						125	22,31
165	28,58						

## N 01 Ohjaustappi

Tilaukoodi:

1 kpl N01 Ø 22/36/25

3 kpl N01 Ø24/36/25

Erikoismittoja tilauksesta

Raaka-aine: 1.7139 ca. 700HV

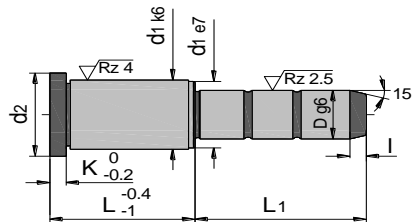

K	d1	d2	l	D	L	L1	€
6	30	35	7	22/24	36	25	7,31
						45	11,51
						50	12,71
						55	13,58
						60	14,22
						70	15,55
						75	16,12
						80	16,91
						95	19,21
						115	22,31
						135	25,18
165	30,16						
6	30	35	7	22/24	46	25	9,92
						45	13,58
						50	14,22
						60	15,55
						65	16,12
						70	16,91
						80	18,42
						85	19,21
						105	22,31
						125	25,18
						165	31,60
6	30	35	7	22/24	56	25	11,51
						45	14,68
						55	16,12
						75	19,21
						95	22,31
						115	25,18
						165	32,55
6	30	35	7	22/24	66	55	17,94
						75	20,81
						95	23,58

K	d1	d2	l	D	L	L1	€
6	30	35	7	22/24	76	25	14,68
						45	17,78
						55	19,21
						75	22,31
						95	25,18
						115	28,58
6	30	35	7	22/24	86	55	20,81
						75	23,58
						95	26,59
6	30	35	7	22/24	96	55	22,31
						75	25,18
						95	28,58
6	30	35	7	22/24	116	75	28,58
						115	33,98
						155	37,79
6	30	35	7	22/24	136	135	37,79
6	42	47	7	30/32	27	45	8,73
						65	13,18
						105	18,81
						165	27,70
6	42	47	7	30/32	36	55	13,42
						75	15,72
						95	18,90
						115	21,92
6	42	47	7	30/32	46	55	13,42
						65	15,72
						85	18,90
						105	21,92
6	42	47	7	30/32	46	125	24,54
						165	30,81

## N 01

### Ohjaustappi

Tilauskoodi:

1 kpl N01 Ø 30/56/55

3 kpl N01 Ø32/56/55

Erikoismittoja tilauksesta

Raaka-aine: 1.7139 ca. 700HV

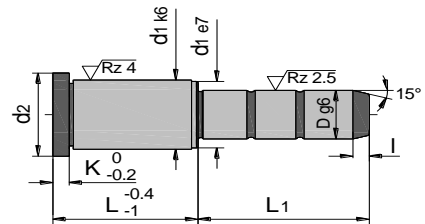

K	d1	d2	l	D	L	L1	€
6	42	47	7	30/32	56	55	15,72
						75	18,90
						95	21,92
						115	24,54
						135	27,70
						175	33,74
6	42	47	7	30/32	66	55	17,38
						75	20,49
						95	23,26
						115	25,96
						135	29,38
						175	34,85
6	42	47	7	30/32	76	55	18,90
						75	21,92
						95	24,54
						115	27,70
						155	33,74
						6	42
75	23,26						
95	25,96						
115	29,38						
155	34,85						
6	42	47	7	30/32	96		
						75	24,54
						95	27,79
						115	30,81
						155	36,36
						6	42
115	33,74						
155	38,04						
6	42	47	7	30/32	136		
						115	36,36
						155	39,78
						6	42
155	41,53						

K	d1	d2	l	D	L	L1	€
6	42	47	7	30/32	176	135	42,87
						175	44,82
						6	42
195	46,13						
10	54	59	10	40/42	56		
						115	36,36
						155	45,33
						195	54,54
10	54	59	10	40/42	66	75	30,49
						135	42,95
10	54	59	10	40/42	76	75	32,78
						115	40,66
						175	54,54
10	54	59	10	40/42	86	75	34,53
						135	47,39
10	54	59	10	40/42	96	75	36,36
						115	45,33
						155	54,54
10	54	59	10	40/42	116	95	45,33
						135	54,54
						195	69,15
10	54	59	10	40/42	136	95	49,39
						135	59,79
						215	84,23
10	54	59	10	40/42	156	115	59,79
						155	69,15
						215	88,28
10	54	59	10	40/42	176	135	69,96
						155	76,41
						175	82,46

## N 01

### Ohjaustappi

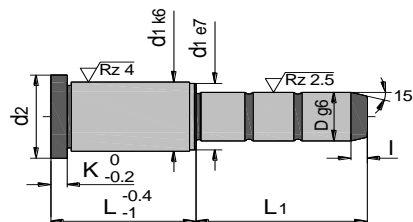

Tilauskoodi:

1 kpl N01 Ø 40/196/155

3 kpl N01 Ø42/196/155

Erikoismittoja tilauksesta

Raaka-aine: 1.7139 ca. 700HV

K	d1	d2	l	D	L	L1	€
10	54	59	10	40/42	196	155	81,85
						195	94,64
						235	106,23
10	54	59	10	40/42	246	165	101,77
						245	120,58
10	66	71	10	50/52	96	115	61,05
						155	72,80
						195	85,59
10	66	71	10	50/52	116	135	71,37
						155	77,25
						195	89,48
10	66	71	10	50/52	136	135	76,62
						155	82,81
						195	95,04
10	66	71	10	50/52	156	155	88,85
						195	101,14
						235	113,61
10	66	71	10	50/52	196	175	102,82
						195	108,37
						235	120,60
20	80	86	10	60/62	96	115	75,51
						155	91,15
						195	106,71
20	80	86	10	60/62	116	135	88,28
						155	95,58
						195	108,93
20	80	86	10	60/62	136	135	97,02
						155	102,18
						195	117,26

K	d1	d2	l	D	L	L1	€
20	80	86	10	60/62	156	155	115,60
						195	129,02
						235	144,81
20	80	86	10	60/62	196	175	134,10
						195	139,42
						235	154,73
20	80	86	10	60/62	246	195	152,67
						235	163,72
						275	179,52
						315	192,30



## N 02

### Ohjaustappi peräohjauksella

Tilauskoodi:

1 kpl N02 Ø 9/12/25

3 kpl N02 Ø10/12/25

Erikoismittoja tilauksesta

Raaka-aine: 1.7139 ca. 700HV

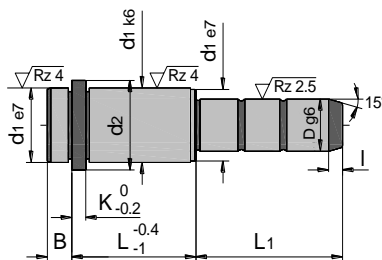

B	K	d1	d2	l	D	L	L1	€
3	3	14	16	4	9/10	12	25	5,16
							45	6,83
							65	8,73
3	3	14	16	4	9/10	17	20	5,16
							25	5,47
							30	6,12
							35	6,44
							50	8,18
							55	8,41
							70	9,21
75	9,77							
3	3	14	16	4	9/10	22	25	6,12
							35	6,84
							55	8,73
							75	9,77
							95	10,72
3	3	14	16	4	9/10	27	20	6,51
							25	6,66
							30	6,83
							45	8,10
							50	8,73
							70	9,77
90	10,72							
3	3	14	16	4	9/10	36	25	7,23
							35	7,85
							45	8,73
							65	9,92
85	10,89							
3	3	14	16	4	9/10	46	30	8,73
							35	8,97
							45	9,45
							70	10,72
3	3	14	16	4	9/10	56	35	9,45
							60	10,72

B	K	d1	d2	l	D	L	L1	€
9	6	20	25	5	14/15	17	35	6,83
							55	9,05
							75	11,35
							95	13,10
9	6	20	25	5	14/15	22	30	6,98
							50	9,05
							70	11,35
							90	13,10
							110	15,41
							125	17,30
							150	20,09
9	6	20	25	5	14/15	27	30	7,31
							45	9,05
							65	11,35
							85	13,10
							105	15,41
							125	18,03
9	6	20	25	5	14/15	36	35	9,05
							55	11,35
							75	13,10
							95	15,41
125	18,98							
155	24,46							
9	6	20	25	5	14/15	46	35	9,77
							45	11,35
							65	13,10
							85	15,41
105	18,03							
125	20,09							
145	24,46							
9	6	20	25	5	14/15	56	35	11,35
							55	13,10
							75	15,41
							95	18,03
135	24,46							





## N 02

### Ohjaustappi peräohjauksella

Tilauskoodi:

1 kpl N02 Ø 18/96/55

3 kpl N02 Ø20/96/55

Erikoismittoja tilauksesta

Raaka-aine: 1.7139 ca. 700HV

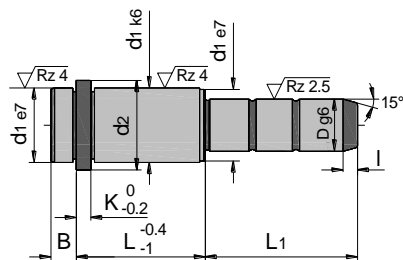

B	K	d1	d2	l	D	L	L1	€
9	6	26	31	7	18/20	96	55	20,81
							95	25,40
9	6	26	31	7	18/20	116	75	25,40
							115	30,57
9	6	26	31	7	18/20	136	135	35,81
9	6	30	35	7	22/24	17	35	11,03
							55	12,71
							75	15,65
9	6	30	35	7	22/24	22	35	11,51
							55	13,50
							75	16,36
							105	20,64
							130	24,30
9	6	30	35	7	22/24	27	35	11,99
							45	12,71
							65	15,65
							85	18,18
							105	21,36
							125	24,30
							165	30,81
							285	43,60
9	6	30	35	7	22/24	36	35	12,71
							55	15,65
							75	18,18
							95	21,36
							115	24,30
							135	27,39
							165	32,00
							205	37,16
							285	44,47

B	K	d1	d2	l	D	L	L1	€
9	6	30	35	7	22/24	46	35	15,16
							45	15,65
							65	18,18
							85	21,36
							105	24,30
9	6	30	35	7	22/24	56	35	15,65
							55	18,18
							75	21,36
							95	24,30
							165	34,85
9	6	30	35	7	22/24	66	35	18,03
							55	20,00
							75	22,94
							95	25,73
							155	34,85
9	6	30	35	7	22/24	76	55	21,36
							75	24,30
							95	27,47
							115	30,81
							145	34,85
9	6	30	35	7	22/24	86	55	22,94
							75	25,73
							95	29,38
							135	34,85
9	6	30	35	7	22/24	96	55	24,30
							75	27,47
							95	30,81
							125	34,85

## N 02

### Ohjaustappi peräohjauksella

Tilauskoodi:

1 kpl N02 Ø 22/116/75

3 kpl N02 Ø24/116/75

Erikoismittoja tilauksesta

Raaka-aine: 1.7139 ca. 700HV

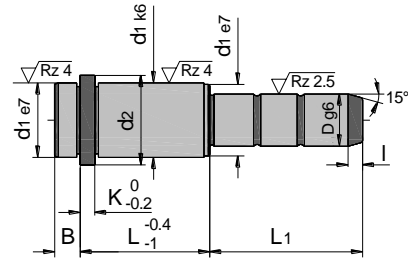

B	K	d1	d2	l	D	L	L1	€
9	6	30	35	7	22/24	116	75	30,81
							115	35,81
							155	40,09
9	6	30	35	7	22/24	136	95	35,81
							135	40,09
9	6	30	35	7	22/24	156	155	43,60
9	6	42	47	7	30/32	27	45	13,10
							65	15,96
							105	21,52
							165	30,57
							185	33,74
							245	41,05
							285	44,22
9	6	42	47	7	30/32	36	55	15,96
							75	18,34
							95	21,53
							115	24,69
							155	30,57
							245	41,60
							285	45,33
9	6	42	47	7	30/32	46	45	15,96
							65	18,34
							85	21,52
							105	24,69
							125	27,55
							165	33,74
							245	42,41
285	46,13							
9	6	42	47	7	30/32	56	55	18,34
							75	21,52
							95	24,69
							115	27,55
							135	30,57
							175	36,36
							245	43,28
295	46,85							

B	K	d1	d2	l	D	L	L1	€
9	6	42	47	7	30/32	66	55	20,09
							75	23,11
							95	25,89
							115	28,83
							135	31,68
9	6	42	47	7	30/32	76	175	37,47
							245	42,41
							295	47,08
							55	21,52
							75	24,69
9	6	42	47	7	30/32	86	95	27,55
							115	30,57
							155	36,36
							225	43,28
							55	23,11
9	6	42	47	7	30/32	96	75	25,89
							95	28,83
							115	31,68
							155	37,47
							225	42,41
9	6	42	47	7	30/32	116	55	24,69
							75	27,55
							95	30,57
							115	33,74
							155	38,98
9	6	42	47	7	30/32	136	75	31,13
							115	36,36
							155	41,05
9	6	42	47	7	30/32	156	95	36,36
							115	38,98
							155	42,41
9	6	42	47	7	30/32	176	115	41,05
							155	45,35
							175	48,42

## N 02

### Ohjaustappi peräohjauksella

Tilauskoodi:

1 kpl N02 Ø 30/196/155

3 kpl N02 Ø32/196/155

Erikoismittoja tilauksesta

Raaka-aine: 1.7139 ca. 700HV

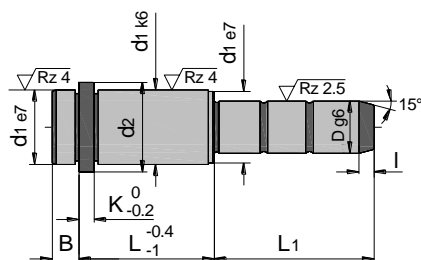

B	K	d1	d2	l	D	L	L1	€
9	6	42	47	7	30/32	196	155	46,85
							195	48,51
12	10	54	59	10	40/42	46	95	34,29
							165	48,51
12	10	54	59	10	40/42	56	75	32,23
							115	40,09
							155	48,51
							195	58,11
12	10	54	59	10	40/42	66	75	34,29
							135	46,52
12	10	54	59	10	40/42	76	75	36,36
							115	44,22
							175	58,11
12	10	54	59	10	40/42	86	75	38,04
							135	50,81
12	10	54	59	10	40/42	96	75	40,09
							115	48,51
							155	58,11
12	10	54	59	10	40/42	116	95	48,51
							135	58,11
							195	72,65
12	10	54	59	10	40/42	136	95	53,44
							135	63,36
							215	85,43
12	10	54	59	10	40/42	156	115	60,42
							155	72,65
							215	90,11
12	10	54	59	10	40/42	176	135	74,84
							155	81,42
							175	87,79

B	K	d1	d2	l	D	L	L1	€
12	10	54	59	10	40/42	196	155	85,43
							195	97,58
							235	112,67
12	10	54	59	10	40/42	246	165	105,67
							245	124,89

## N 03

### Ohjausholkki

Tilaukoodi:

1 kpl N03 Ø 9/9

3 kpl N03 Ø10/9

Erikoismittoja tilauksesta

Raaka-aine: 1.7139 ca. 700HV

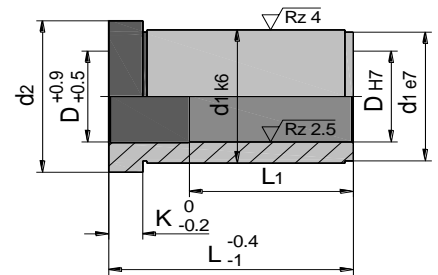

K	d1	d2	L1	D	L	€
3	14	16	-	9/10	9	3,97
					12	4,52
					17	5,08
					22	5,40
					27	5,79
			27		36	7,78
					46	10,01
					56	13,18
					66	16,52
					6	18
36	22	5,72				
	27	6,34				
	36	8,34				
	46	10,48				
	56	13,50				
	6	20	25	-	14/15	12
46	17	5,63				
	22	5,95				
	27	6,66				
	36	8,66				
	46	10,89				
	56	14,22				
	66	16,12				
76	18,18					
86	21,20					
96	24,30					

K	d1	d2	L1	D	L	€					
6	22	27	-	16	17	6,66					
					22	7,07					
					27	7,54					
					36	9,28					
					46	10,89					
					56	13,97					
					6	26	31	-	18/20	17	6,91
					56	22	7,23				
27	7,70										
36	9,53										
46	11,19										
56	14,37										
66	16,67										
76	19,06										
86	21,60										
96	24,30										
116	31,68										
6	30	35	-	22/24	17	7,46					
					22	8,18					
					27	8,89					
					36	9,92					
					46	12,39					
					56	15,33					
					66	17,78					
					76	20,17					
					76	86	22,63				
						96	25,40				
						116	33,42				
						136	40,34				
156	47,64										

## N 03

### Ohjausholkki

Tilauskoodi:

1 kpl N03 Ø 30/22

3 kpl N03 Ø32/22

Erikoismittoja tilauksesta

Raaka-aine: 1.7139 ca. 700HV

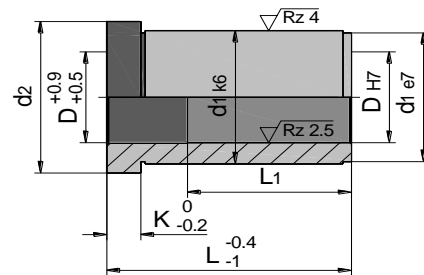

K	d1	d2	L1	D	L	€					
6	42	47	-	30/32	22	7,61					
					27	8,10					
					36	9,92					
					46	12,39					
					56	15,41					
					66	17,94					
					76	20,49					
					86	23,18					
					96	25,80					
					96	42	47	-	30/32	116	33,19
										136	39,78
										156	45,89
										176	52,40
										186	56,49
196	60,57										
236	76,91										
10	54	59	-	40/42						36	17,38
										46	22,24
										56	27,47
					66	31,13					
					76	34,29					
					86	38,43					
					96	43,28					
					116	49,70					
					116	54	59	-	40/42	136	56,60
										156	65,03
										176	74,24
										196	82,49
										216	91,31
										246	104,01

K	d1	d2	L1	D	L	€					
10	66	71	-	50/52	56	25,40					
					76	34,29					
					96	42,95					
					116	52,01					
					136	63,91					
					156	74,95					
					176	82,41					
					196	91,79					
					20	80	86	-	60/62	56	33,03
										76	44,78
96	56,60										
116	67,97										
136	81,29										
156	95,19										
176	103,93										
196	115,04										
216	124,96										
246	142,36										
20	104	112	-	80	96	115,64					
					116	125,37					
					136	136,57					
					156	150,69					
					176	167,96					
					196	183,14					
					216	201,77					
					246	230,03					

## N 035

### Pronssinen ohjausholkki

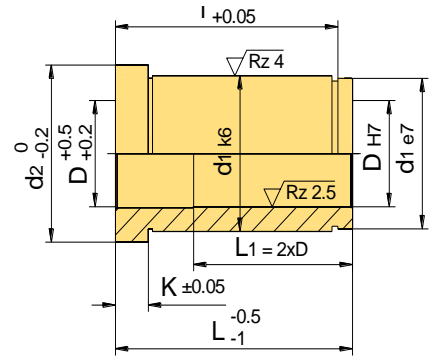
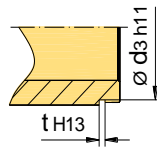

Tilauskoodi:

1 kpl N035 Ø 9/12

3 kpl N035 Ø10/12

Erikoiskokoja tilauksesta

Raaka-aine: Pronssi

K	d1	d2	d3	t	l	D	L	€
3	14	16	13,4	1,10	9,6	9/10	12	6,81
							14,6	7,38
							19,6	7,85
							24,6	8,64
							33,6	9,99
							43,6	11,41
							53,6	12,82
6	18	23	17,0	1,30	14,3	12	17	7,85
							19,3	8,64
							24,3	9,52
							33,3	11,14
							43,3	13,02
							53,3	14,92
6	20	25	19,0	1,30	14,3	14/15	17	8,11
							19,3	8,89
							24,3	9,68
							33,3	11,57
							43,3	13,50
							53,3	15,44
6	22	27	21,0	1,30	19,3	16	22	9,47
							24,3	10,21
							33,3	12,29
							43,3	14,39
							53,3	16,48
6	26	31	24,9	1,30	14,3	18/20	17	10,21
							19,3	10,99
							24,3	11,77
							33,3	13,34
							43,3	14,92
							53,3	17,42
							63,3	19,93
73,3	22,50							

K	d1	d2	d3	t	l	D	L	€
6	30	35	28,6	1,60	18,6	22/24	22	12,04
							27	12,82
							36	14,97
							42,6	17,27
							52,6	19,62
							62,6	22,03
							72,6	24,44
							82,6	26,84
							92,6	29,41
							6	42
30,9	23,81							
40,9	27,06							
50,9	30,30							
60,9	33,54							
70,9	37,62							
6	54	60	51,0	2,15	40,2	40/42	46	39,25
							50,2	43,33
							60,2	47,41
							70,2	51,54
							80,2	56,78
6	54	60	51,0	2,15	40,2	40/42	90,2	62,01
							110,2	69,60
							130,2	77,96





## N 045

Pronssinen ohjausholkki  
Peräohjauksella

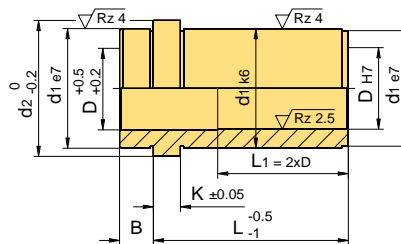

Tilauskoodi:

1 kpl N045 Ø 9/12

3 kpl N045 Ø10/12

Erikoismittoja tilauksesta

Raaka-aine pronssi

B	K	d1	d2	D	L	€
5	3	14	16	9/10	12	7,85
					17	8,42
					22	8,89
					27	9,68
					36	11,14
					46	12,66
					56	14,12
6	6	20	25	14/15	17	9,37
					22	10,21
					27	10,99
					36	12,97
					46	15,02
					56	17,00
					66	18,42
8	6	26	31	18/20	17	11,77
					22	12,72
					27	13,65
					36	15,65
					46	17,63
					56	19,62
					66	21,88
8	6	30	35	22/24	22	14,12
					27	15,17
					36	17,42
					46	19,68
					56	21,93
					66	24,44
					76	26,94
					86	29,35
					96	31,65
					116	39,66

B	K	d1	d2	D	L	€
8	6	42	47	30/32	27	24,33
					36	26,42
					46	29,62
					56	32,92
					66	36,10
					76	40,24
					86	44,53
					96	48,67
					116	53,63
					136	58,86
10	10	54	60	40/42	46	43,01
					56	47,35
					66	51,43
					76	55,51
					86	61,69
					96	67,87
					116	74,04
					136	82,15
					156	90,10
					196	104,44

## N 046

### Pronssinen ohjausholkki

ulostyöntöpakettille

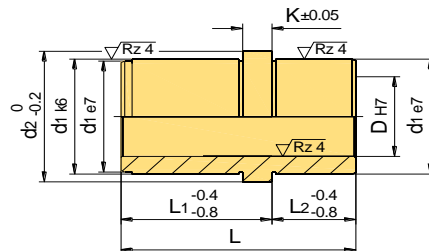

Tilauskoodi:

1 kpl N046 Ø14/17

1 kpl N046 Ø15/17

Erikoismittoja tilauksesta

Raaka-aine pronssi

K	d1	d2	L	L2	D	L1	€
6	20	25	24,3	8,5	14/15	17	10,72
6	26	31	37,3	16,5	18/20	22	14,12
6	30	35	47,3	21,5	22/24	27	18,32
6	42	46	61,3	26,5	30/32	36	30,61

## N 047

### Pronssinen ohjausholkki

ulostyöntöpakettille

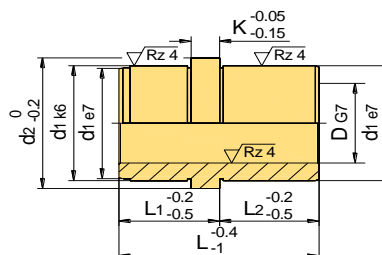

Tilauskoodi:

1 kpl N047 Ø12/6

Erikoismittoja tilauksesta

Raaka-aine pronssi

K	d1	d2	L	L2	D	L1	€
3	16	19	15	9	12	6	7,59
3	16	19	21	12	12	9	8,37
3	16	19	29	17	12	12	9,42
6	25	29	29	17	18	12	10,99
6	25	29	39	22	18	17	12,82
6	25	29	49	27	18	22	15,17
6	42	46	39	22	30	17	23,81
6	42	46	49	27	30	22	26,16
6	42	46	63	36	30	27	30,61

## N 048

### Pronssinen ohjausholkki

ulostyönön ohjaukseen

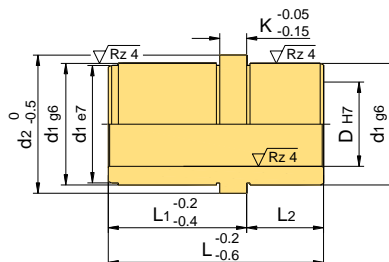

Tilauskoodi:

1 kpl N048 Ø10/9/12

Erikoismittoja tilauksesta

Raaka-aine pronssi

K	d1	d2	L	D	L2	L1	€
6	14	17	21	10	9	12	7,33
6	14	17	26	10	9	17	7,85
6	16	19	26	12	9	17	8,11
6	16	19	29	12	12	17	8,64
6	18	21	29	14	12	17	9,16
6	18	21	34	14	12	22	10,21
6	18	21	29	14	17	22	10,59
6	24	27	29	18	12	17	10,47
6	24	27	34	18	12	22	11,77
6	24	27	39	18	17	22	13,09
6	24	27	44	18	17	27	14,39
6	24	27	49	18	22	27	15,63
6	26	29	39	20	17	22	14,70
6	26	29	49	20	22	27	16,35
6	28	31	39	22	17	22	14,92
6	28	31	49	22	22	27	17,00
6	30	33	39	24	17	22	15,44
6	30	33	44	24	17	27	16,48
6	30	33	49	24	22	27	17,53
6	30	33	63	24	27	36	20,41
6	38	41	49	30	22	27	26,16
6	38	41	63	30	27	36	29,57
6	38	41	73	30	27	46	31,92

## N 05

### Keskitysholkki

Tilaukoodi:

1 kpl N05 Ø14/20

Erikoismittoja tilauksesta

Raaka-aine: 1.7139 ca. 700HV

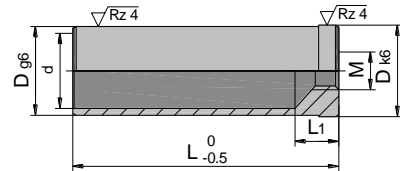

L1	M	d	D	L	€
8	8	11	14	20	2,94
				30	3,18
				40	3,50
				50	3,97
				60	4,45
				70	4,92
				80	5,47
				100	6,66
12	12	16	20	30	4,13
				40	4,45
				50	4,92
				60	5,33
				70	5,88
				80	6,44
				100	7,70
				120	8,97
				140	10,57
				160	12,54
12	12	21	26	30	5,24
				40	5,72
				50	6,20
				60	6,59
				70	6,99
				80	7,54
				100	8,66
				120	9,92
				140	11,76
				160	13,50
				180	15,41
12	12	25	30	40	6,12
				50	6,66
				60	7,31
				80	8,41
				100	9,92
				120	11,76
				140	13,97
				160	15,87
				180	17,87
				200	19,45
				220	20,98
				240	22,24

## N 05

### Keskitysholkki

Tilaukoodi:

1 kpl N05 Ø42/40

Erikoismittoja tilauksesta

Raaka-aine: 1.7139 ca. 700HV

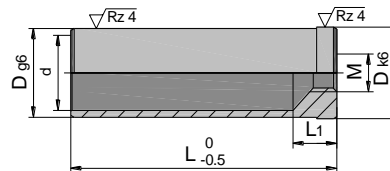

L1	M	d	D	L	€
12	12	33	42	40	6,51
				60	7,78
				80	9,45
				100	10,79
				120	12,71
				140	14,68
				160	16,75
				180	18,66
				200	20,24
				220	21,52
				240	22,94
				260	24,06
				280	25,29
				300	26,12
12	12	43	54	60	16,75
				80	20,64
				100	24,15
				120	26,44
				140	29,66
				160	31,68
				200	37,47
				240	43,91
				280	49,70
				320	58,67
18	20	54	66	80	39,76
				100	42,91
				120	46,57
				140	50,55
				160	54,42
				180	58,55
				200	62,27
				240	77,96
				280	89,27
				320	101,30
18	20	64	80	100	64,67
				120	71,68
				140	79,32
				160	86,34
				200	100,77
				240	123,28
				280	153,84
				320	177,91



## N 051

### Keskitysholkki

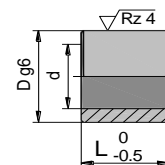

Tilauskoodi:

1 kpl N051 Ø14

Erikoismittoja tilauksesta

Raaka-aine: 1.7139 ca. 700HV

d	D	L	€
9	14	11,5	2,93
11	16	13,5	3,08
13	20	15,5	3,14
16	26	17,5	4,01

d	D	L	€
18	30	19,5	4,18
22	36	19,5	4,71
26	42	19,5	5,23
32	54	19,5	7,30

## N 06

### Kartio-ohjauspari

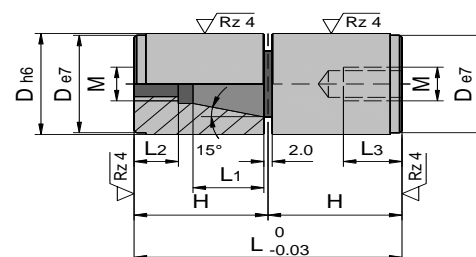

Tilauskoodi:

1 kpl N06 Ø12

Erikoismittoja tilauksesta

Raaka-aine: 1.7139 ca. 700HV

L1	L2	M	L3	H	L	D	€
4	9	4	10	17	34	12	30,81
6	9	5	10	17	34	14	33,19
6	9	5	10	17	34	16	34,85
9	11	8	16	27	54	20	38,43
10	11	8	16	27	54	25	42,41

L1	L2	M	L3	H	L	D	€
10	11	8	16	27	54	26	43,28
14	13	10	20	36	72	30	48,19
14	13	10	20	36	72	32	49,46
18	13	10	20	46	92	42	58,67

## N 065

### Kartio-ohjauspari

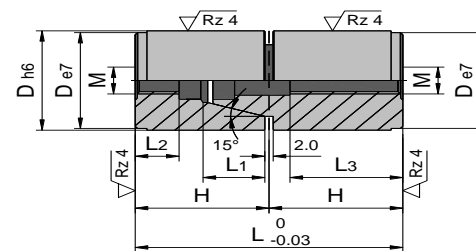

Tilauskoodi:

1 kpl N065 Ø12

Erikoismittoja tilauksesta

Raaka-aine: 1.7139 ca. 700HV

L1	L2	M	L3	H	L	D	€
5	8,5	4	9,6	17	34	12	32,34
7	6	5	12,4	17	34	14	34,75
7	6	5	12,4	17	34	16	36,73
10	10,5	8	19,7	27	54	20	40,18
11	9	8	19,7	27	54	25	44,58

L1	L2	M	L3	H	L	D	€
11	9	8	19,7	27	54	26	45,52
16	12,2	10	25	36	72	30	50,55
16	12,2	10	25	36	72	32	51,60
20	16,5	10	27	46	92	42	61,84

## N 61

### Korokepala

Tilaukoodi

1 kpl N61 Ø12/3

Erikoismittoja tilauksesta

Raaka-aine: 1.7139 ca. 700HV

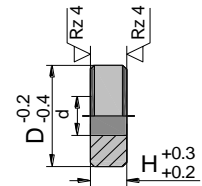

d	H	D	€
4,5	3	12	2,46
4,5	9	12	2,56
4,5	10	12	2,62
5,5	3	14	2,51
5,5	5	14	2,62
5,5	9	14	2,67
5,5	10	14	2,72
5,5	14	14	3,55
5,5	19	14	3,65
5,5	3	16	2,62
5,5	5	16	2,78
5,5	9	16	2,83
5,5	10	16	2,88
5,5	19	16	3,89
8,5	3	20	2,93
8,5	9	20	3,26
8,5	10	20	3,36
8,5	20	20	4,37
8,5	9	25	3,65
8,5	10	25	3,75
8,5	20	25	4,89

d	H	D	€
8,5	3	26	3,03
8,5	9	26	3,79
8,5	10	26	3,89
8,5	20	26	5,01
8,5	30	26	6,59
11,0	4	30	3,56
11,0	10	30	4,37
11,0	20	30	5,63
11,0	30	30	7,07
11,0	10	32	4,45
11,0	20	32	5,95
11,0	4	42	4,08
11,0	10	42	5,63
11,0	20	42	7,38
11,0	30	42	8,57
13,5	20	54	8,73
13,5	40	54	10,89
17,5	20	80	16,52
17,5	40	80	19,30

## N 62 Pidätinlevy

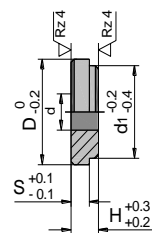

Tilaukoodi:

1 kpl N62 Ø14

Erikoismittoja tilauksesta

Raaka-aine: 1.7139 ca. 700HV

H	S	d	D	d1	€
5	3,2	5,5	16,0	14	3,33
9	6,3	8,5	25,5	20	4,29
9	6,3	8,5	31,5	26	5,16
10	6,3	11,0	35,5	30	5,88
10	6,3	11,0	47,5	42	7,78

## N 63 Keskityspala

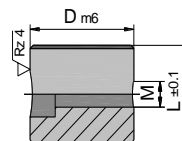

Tilaukoodi:

1 Stück N63 Ø20

Erikoismittoja tilauksesta

Raaka-aine: 1.7139 ca. 700HV

M	L	D	€
6	20	20	9,13
6	25	26	10,48
8	30	30	12,63
8	40	42	15,09

## N 07 Vinotappi

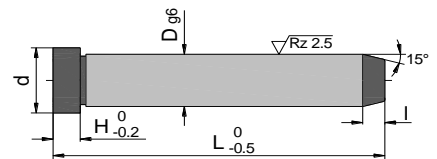

Tilauskoodi:

1 kpl N07 Ø8/40

Erikoismittoja tilauksesta

Raaka-aine: 1.7139 ca. 700HV

d	l	H	D	L	€
10	4	3	8	40	2,84
				50	2,84
				60	2,84
				80	2,95
				100	3,17
12	4	3	9	40	2,78
				60	2,86
				80	2,94
				100	3,26
				120	3,73
12	4	3	10	40	2,78
				60	2,86
				80	2,94
				100	3,26
				120	3,73
				140	6,01
16	5	6	12	40	2,94
				60	3,18
				80	3,41
				100	3,81
				120	4,20
				140	4,69
				160	5,08
18	5	8	14	60	3,33
				80	3,50
				100	4,05
				120	4,45
				140	5,33
				160	6,27
				180	7,07
				200	9,61
				220	10,16
				240	11,26

d	l	H	D	L	€
18	5	8	15	60	3,33
				80	3,50
				100	4,05
				120	4,52
				140	5,33
				160	6,27
				180	7,07
				200	9,61
				240	11,26
20	5	8	16	40	3,50
				60	3,58
				80	3,89
				100	4,45
				120	5,01
				140	5,79
				160	6,66
				180	7,46
				200	8,25
22	7	8	18	60	3,89
				80	4,29
				100	4,84
				120	5,47
				140	6,27
				160	6,98
				180	7,95
				200	8,73
				220	9,92
24	7	8	20	60	4,45
				80	4,76
				100	5,33

## N 07 Vinotappi

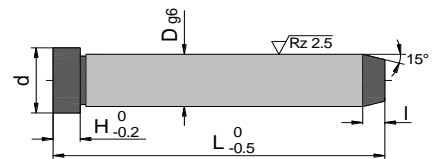

Tilauskoodi:

1 kpl N07 Ø20/120

Erikoismittoja tilauksesta

Raaka-aine: 1.7139 ca. 700HV

d	l	H	D	L	€
24	7	8	20	120	6,34
				140	6,98
				160	7,78
				180	8,82
				200	10,01
				220	11,03
				240	12,54
				260	16,93
				280	19,12
				300	20,54
				320	22,17
26	7	15	22	80	5,56
				100	6,27
				120	7,63
				140	8,41
				160	9,13
				180	10,01
				200	11,03
				220	12,47
				240	13,73
				260	15,18
				280	16,60
300	18,03				
320	21,63				
340	22,94				
360	25,12				
28	7	15	24	80	6,27
				100	7,14
				120	8,50
				140	9,13
				160	9,92
				180	10,79
				200	11,60
				220	13,42
				240	15,16
				260	16,66
				280	18,13
300	19,61				
320	23,27				
340	24,86				
360	27,31				

d	l	H	D	L	€
36	7	15	30	100	9,77
				120	11,19
				140	12,46
				160	13,73
				180	14,93
				200	16,12
				240	21,68
				300	28,19
				360	36,04
				400	41,52
				36	7
120	11,19				
140	12,46				
160	13,73				
180	14,93				
200	16,12				
240	21,68				
300	28,19				
360	36,04				
400	42,94				
48	10	15	40		
				200	31,13
				240	35,81
				300	42,95
				360	50,81
				400	57,36
				420	60,09
500	69,65				
58	15	15	50	160	40,97
				200	45,33
				240	50,58
				300	58,67
				360	67,97
				400	74,57
68	20	20	60	280	77,30
				300	81,94
				340	90,96
				360	95,87
				400	104,06
				500	126,19

## N 072

### Vinotappi kartiokannalla

Tilauskoodi

1 kpl N072 Ø10/40

Erikoismittoja tilauksesta

Raaka-aine: 1.7139 ca. 700HV

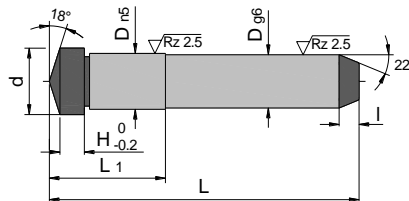

d	H	I	L1	D	L	€
12	2	4	13	10	40	4,21
					60	4,29
					80	4,61
					100	5,44
					120	5,76
15	3	5	17	12	60	4,61
					80	5,03
					100	5,76
					120	6,07
					140	6,91
				160	7,64	
17	3	5	17	14	60	4,91
					80	5,44
					100	6,28
					120	6,91
					140	7,64
				160	8,27	
19	3	5	22	16	60	5,03
					80	5,76
					100	6,91
					120	7,64
					140	8,27
					160	9,00
				180	10,04	
				200	10,78	
21	3	7	22	18	60	5,44
					80	6,28
					100	7,33
					120	8,27
					140	9,21
					160	9,84
					180	10,47
					200	11,72
				220	13,19	
				240	14,80	

d	H	I	L1	D	L	€
23	4	7	22	20	80	6,91
					100	7,85
					120	9,00
					140	10,04
					160	11,09
					180	12,14
				200	12,87	
				220	13,92	
				240	14,97	
25	4	7	27	22	60	6,59
					80	7,33
					100	8,37
					120	9,63
					140	10,78
					160	12,04
				180	13,09	
				200	14,12	
				220	15,28	
				240	16,43	
27	4	7	27	24	80	7,85
					100	9,00
					120	10,36
					140	11,41
					160	12,87
					180	13,92
					200	15,38
				220	16,64	
				240	17,90	
				280	20,41	
35	5	7	36	30	100	11,09
					120	12,87
					140	14,75
					160	16,02
					180	17,90
					200	19,68
					220	21,14
					240	23,03
					280	26,06
				320	29,62	
				360	32,87	



## N 074

Vinotappi ilman kantaa

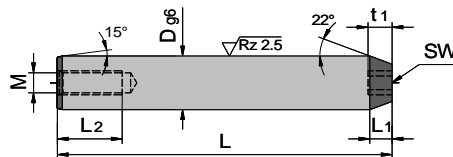

Tilaukscodi:

1 kpl N074 Ø8/40

Erikoismittoja tilauksesta

Raaka-aine: 1.7139 ca. 700HV

M	L2	L1	SW	t1	D	L	€
5	10	2,3	4	4	8	40	5,45
						60	5,55
						80	5,96
						100	6,91
6	10	4	4	4	10	40	5,45
						60	5,55
						80	5,96
						100	6,91
						120	7,33
6	10	5	5	5	12	60	5,76
						80	6,18
						100	7,11
						120	7,54
						140	8,58
						160	9,42
6	10	5	5	5	14	50	5,55
						60	5,76
						70	5,96
						75	6,07
						80	6,18
						90	6,81
						100	7,43
						120	8,06
						140	9,00
8	17	5	5	5	15	50	5,65
						60	5,76
						70	6,07
						80	6,38
						90	7,01

M	L2	L1	SW	t1	D	L	€
8	17	5	6	6	16	60	5,76
						80	6,59
						90	7,22
						100	7,85
						120	8,69
						130	9,11
						140	9,42
8	17	7	6	6	18	60	6,18
						70	6,59
						80	6,91
						90	7,43
						100	7,96
						120	9,00
						125	9,42
						140	9,94
						150	10,47
						160	10,99
						170	11,51
10	17	7	6	6	18	60	6,18
						70	6,59
						80	6,91
						90	7,43
						100	7,96
						125	9,42
						140	9,94
10	17	7	6	6	18	150	10,47
						170	11,51

## N 074

Vinotappi ilman kantaa

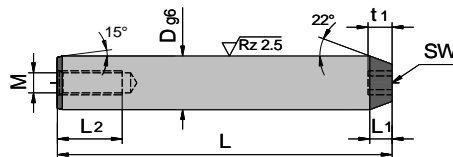

Tilauskoodi:

1 kpl N074 Ø20/60

Erikoismittoja tilauksesta

Raaka-aine: 1.7139 ca. 700HV

M	L2	L1	SW	t1	D	L	€
10	20	7	8	8	20	60	6,49
						70	6,91
						80	7,22
						90	7,74
						100	8,16
						120	9,42
						125	9,74
						140	10,57
						150	11,09
						160	11,62
						165	11,92
						170	12,14
						180	12,66
						190	13,09
					200	13,39	
					210	14,02	
					220	14,65	
					240	15,59	
10	20	7	8	8	22	60	6,91
						70	7,22
						80	7,54
						90	8,16
						100	8,79
						120	9,84
						140	10,99
						160	12,14
						180	13,19
						200	14,23
					220	15,28	
					240	16,53	

M	L2	L1	SW	t1	D	L	€
12	25	7	8	8	24	60	7,54
						70	8,16
						80	8,69
						90	9,31
						100	9,84
						120	11,30
						140	13,50
						145	13,92
						160	16,32
						180	17,27
						190	17,78
					200	18,32	
					220	19,25	
					240	20,51	
16	30	7	10	10	30	80	13,39
						90	14,44
						100	15,49
						120	16,95
						140	18,21
16	30	7	10	10	32	80	13,92
						90	14,97
						100	16,02
						120	17,48
						140	18,73

## N 08

### Ohjaustappi

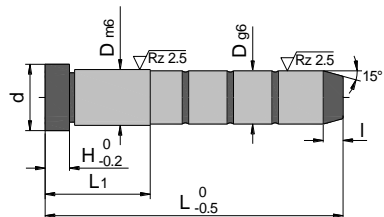

Tilauskoodi:

1 kpl N08 Ø10/40

Erikoismittoja tilauksesta

Raaka-aine: 1.7139 ca. 700HV

d	H	l	L1	D	L	€	
12	3	5	17	10	40	5,01	
					60	5,16	
					80	5,47	
					100	5,79	
16	6	5	17	12	60	5,56	
					80	5,95	
					100	6,51	
					120	7,14	
18	8	5	17	14	60	5,72	
					80	6,20	
					100	6,83	
					120	7,63	
					140	8,57	
					160	9,77	
					180	10,65	
20	8	5	17	16	60	6,12	
					80	6,66	
					100	7,54	
					120	8,25	
					140	9,77	
					160	10,40	
					180	11,47	
					200	12,56	
					240	18,30	

d	H	l	L1	D	L	€	
22	8	7	22	18	80	7,23	
					100	8,10	
					120	9,13	
					140	10,16	
					160	11,19	
					180	12,54	
					200	13,50	
					240	18,03	
					280	21,58	
24	8	7	22	20	80	8,02	
					100	8,82	
					120	10,01	
					140	10,79	
					160	12,22	
					180	13,58	
					200	15,09	
					240	18,84	
					280	22,94	

## N 08

### Ohjaustappi

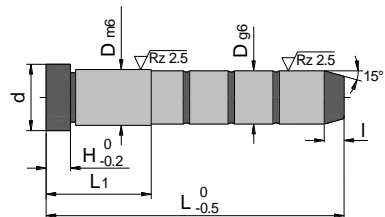

Tilauskoodi:

1 kpl N08 Ø22/100

Erikoismittoja tilauksesta

Raaka-aine: 1.7139 ca. 700HV

d	H	l	L1	D	L	€				
26	15	7	27	22	100	9,92				
			27		120	11,76				
			36		140	12,62				
			36		160	13,73				
			46		180	14,93				
			56		200	16,36				
			56		220	18,18				
			56		240	20,49				
			56		280	22,67				
			56		300	24,03				
			56		320	25,95				
			56		360	29,77				
			28		15	7	27	24	100	10,89
							27		120	12,62
36	140	13,50								
36	160	14,77								
46	180	15,96								
56	200	16,99								
56	220	19,30								
56	240	21,58								
56	280	24,58								
56	300	25,95								
56	320	27,86								
56	360	32,23								
36	15	7		36			30		160	18,74
				56					200	21,75
			56	240	26,12					
			56	280	32,23					
			56	300	33,87					
			56	360	39,61					

d	H	l	L1	D	L	€
36	15	7	36	32	160	18,74
			56		200	21,92
			56		240	26,12
			56		280	32,77
			56		300	34,96
			56		360	40,42
			48		15	10
56	240	39,78				
56	300	47,08				
76	360	54,08				
76	400	58,73				
96	500	70,75				
58	15	15	46	50	200	48,51
			56		240	53,75
			56		300	62,72
			76		360	73,75
			76		400	82,49
			96		500	101,61
68	20	20	56	60	240	77,81
			56		300	87,10
			76		360	98,13
			76		400	105,43
			96		500	130,56

## N 09

### Ohjausputki

Tilauskoodi

1 kpl N09 Ø10/20

Erikoismittoja tilauksesta

Raaka-aine: 1.7139 ca. 700HV

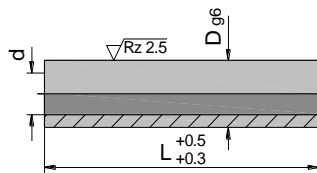

d	D	L	€
6,2	10	20	5,24
		30	5,40
		40	5,95
		50	6,27
		60	6,59
		70	7,07
		80	7,63
		100	8,41
		120	9,13
		140	9,85
8,5	14	30	6,20
		40	6,59
		50	7,07
		60	7,70
		70	8,10
		80	8,57
		100	9,38
		120	10,32
		140	11,19
		160	12,15
10,5	18	40	7,78
		60	8,82
		80	9,85
		100	10,57
		120	11,51
		140	12,39
		160	13,34
		180	14,37
		200	15,33
		220	16,36
240	17,30		

d	D	L	€
13,0	24	60	12,15
		80	13,10
		100	14,14
		120	15,25
		140	16,36
		160	17,30
		180	18,42
		200	19,69
		240	21,92
		17,0	30
100	19,13		
120	20,41		
140	21,43		
160	22,79		
180	24,21		
200	25,80		
220	27,31		
240	29,06		
260	30,81		
280	32,00		
300	33,42		

## N 091

### Korokepala N09 varten

Tilauskoodi

1 kpl N091 Ø14

Raaka-aine: 1.7139 ca. 700HV

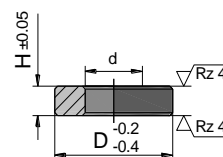

d	H	D	€
6,2	3	14	2,07
8,5	4	18	2,38
10,5	5	24	2,94
13,0	6	30	3,41
17,0	8	40	4,60

## N 10

### Tuurnatappi

Tilaukoodi:

1 kpl N10 Ø10/60

Erikoismittoja tilauksesta

Raaka-aine: 1.7139 ca. 700HV

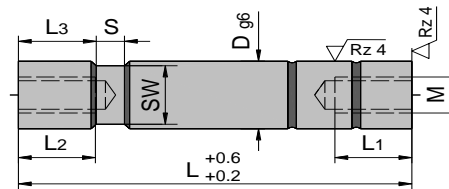

L1	L2	L3	M	S	SW	D	L	€	
10	16	14	6	8	8	10	60	8,25	
							70	8,41	
							80	8,57	
							100	8,82	
							120	9,13	
							140	9,45	
							160	11,10	
17	25	14	8	8	12	14	60	8,97	
							70	9,28	
							80	9,53	
							100	9,60	
							120	9,77	
							140	10,01	
							160	10,57	
							200	12,13	
20	30	16	10	8	14	18	70	10,38	
							80	10,55	
							100	10,72	
							120	11,19	
							140	12,15	
							160	12,31	
							180	12,71	
							200	13,18	
							220	13,58	
							240	14,22	
							12	70	10,38
							80	10,55	
							100	10,72	
							120	11,19	
							140	12,15	
							160	12,31	
							180	12,71	
							200	13,18	
							220	13,58	
240	14,22								
20	30	16	12	10	17	20	70	11,26	
							80	11,35	
							100	11,83	
							120	12,15	
							140	12,94	
							160	13,34	

L1	L2	L3	M	S	SW	D	L	€
20	30	16	12	10	17	20	180	13,97
							200	14,61
							220	15,25
							240	15,80
25	35	22	12	12	19	24	70	13,27
							80	13,55
							100	13,98
							120	14,77
							140	15,41
							160	16,36
							180	17,16
							200	18,18
220	19,23							
240	20,00							
260	21,36							
280	23,38							
30	45	28	16	16	24	30	100	19,53
							120	20,15
							140	20,87
							160	21,79
							180	23,11
							200	24,58
							220	25,64
							260	28,42
300	31,68							
340	33,21							
35	55	36	20	20	36	40	160	31,87
							180	33,51
							200	34,75
							220	36,08
							240	37,42
							260	39,77
							300	43,60
							340	47,14
380	50,92							



## N 101

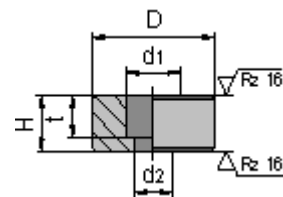

Korokepala

Tilaukscodi:

1 kpl N101 Ø15

Raaka-aine: 1.7139 ca. 700HV

d1	d2	t	H	D	€
11	6,6	8,4	10	15	1,75
14,5	9	11	14	22	4,45
17,5	11	14	20	36	6,2

d1	d2	t	H	D	€
20	14	16	25	46	8,25
26	18	21	32	56	10,72

## N 102

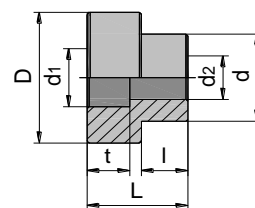

Tilaukscodi:

1 kpl N102 Ø40/7

Erikoismittoja tilauksesta

Raaka-aine: 1.7139

t	d	d1	d2	L	D	I	€
11	25	18	10,5	27	40	7	7,14
11	25	18	10,5	27	40	12	7,14
13	31	20	13,0	32	48	8	8,66
13	31	20	13,0	32	48	17	8,66

t	d	d1	d2	L	D	I	€
17,5	39	26	17	34	58	9	9,85
17,5	39	26	17	34	58	19	9,85

## N 11

### Ulostyönnön holkki

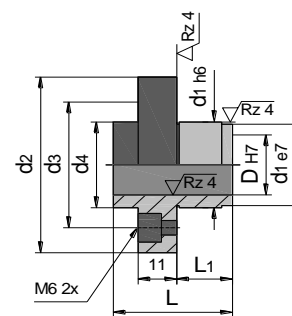

Tilaukscodi:

1 kpl N11 Ø14

Erikoismittoja tilauksesta

Raaka-aine: 1.7139 ca. 700HV

L1	L	d4	d3	d2	d1	D	€
12	29	19	32	46	18	14	18,49
16	34	25	38	52	24	18	20,81

L1	L	d4	d3	d2	d1	D	€
21	40	31	44	58	30	24	24,86
26	46	39	52	68	38	30	30,16

## N 12

### Ulostyönnon holkki

Tilauskoodi:

1 kpl N12 Ø10/17/40

Erikoismittoja tilauksesta

Raaka-aine: 1.7139

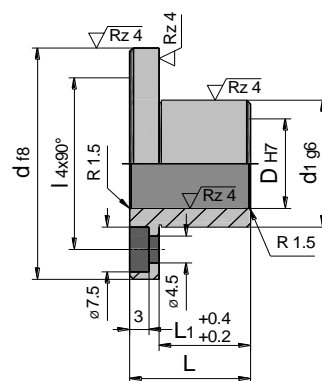
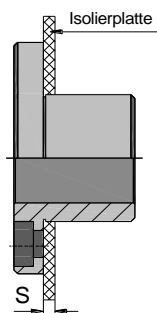

l	d1	S	L1	D	L	d	€
30	22	-	11,9	10	17	40	17,78
30	22	-	11,9	14	17	40	17,78
30	22	-	16,9	10	22	40	19,45
30	22	-	16,9	14	22	40	19,45
30	22	-	11,9	14	17	60	23,26
30	22	-	16,9	14	22	60	25,40
50	32	-	22,0	18	27	100	44,03
50	32	-	31,0	20	36	100	45,78
50	32	-	31,0	24	36	100	47,52
50	32	-	22,0	18	27	110	48,61
50	32	-	31,0	20	36	110	51,89
50	32	-	31,0	24	36	110	53,21
50	32	-	22,0	18	27	125	55,72
50	32	-	31,0	20	36	125	58,12
50	32	-	31,0	24	36	125	59,87

l	d1	S	L1	D	L	d	€
30	22	3	14,9	10	20	40	18,74
30	22	3	14,9	14	20	40	18,74
30	22	3	14,9	14	20	60	24,37
30	22	3	19,9	14	25	60	26,44
30	22	3	21,9	14	27	60	27,70

## N 121

### Ulostyönnon holkki

Tilauskoodi:

1 kpl N121 Ø17/40

Erikoismittoja tilauksesta

Raaka-aine: 1.7139

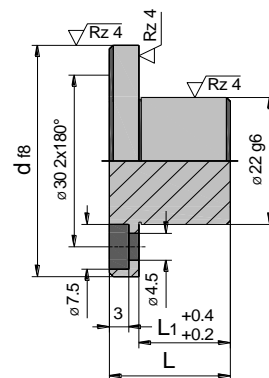
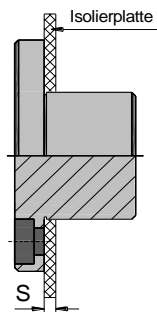

S	L1	L	d	€
-	12	17	40	14,29
-	12	17	60	20,09

S	L1	L	d	€
3	15	20	40	14,61
5	17	22	40	14,93
3	15	20	60	21,20
5	17	22	60	22,24
3	20	25	60	23,18
5	22	27	60	24,37

## N 13

### Kuulakori täydellinen

Tilauskoodi

1 kpl N13 Ø12/40

Erikoismittoja tilauksesta

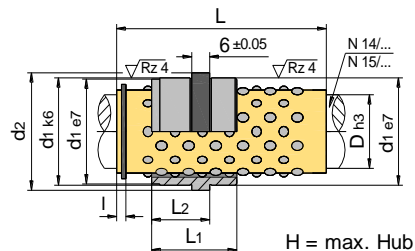

H = max. Hub

l	d1	d2	L1	L2	H	D	L	€
2,5	22	26	24	18	50	12	40	36,10
					82		56	45,84
2,8	30	35	34	23	44	18	45	42,38
					66		56	46,89
					96		71	48,97
4,8	46	52	54	33	32	30	56	64,67
					70		75	73,78
					110		95	76,29

## N 130

### Holkki

Tilauskoodi

1 kpl N130 Ø16

Erikoismittoja tilauksesta

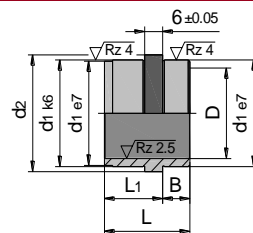

Raaka-aine: 1.7139 ca. 700HV

d1	d2	B	L1	L	D	€
22	26	6	18	24	16	10,47
30	35	11	23	34	24	14,12
46	52	21	33	54	38	20,93

## N 131

### Kuulakori

Tilauskoodi

1 kpl N131 Ø12/40

Erikoismittoja tilauksesta

Raaka-aine: messinki

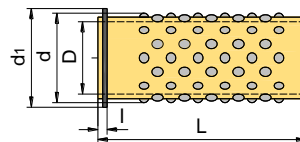

l	d	d1	D	L	€
2,5	16	20,5	12	40	25,64
				56	35,37
2,8	24	28,6	18	45	28,26
				56	32,75
				71	34,85
4,8	38	43,5	30	56	43,74
				75	52,85
				95	55,36

## N 14

### Kuulajohde kannalla

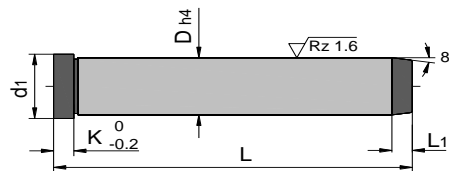

Tilauskoodi:

1 kpl N14 Ø12/80

Erikoismittoja tilauksesta

Raaka-aine: 1.7139 ca. 700HV

K	L1	d1	D	L	€
4	4	16	12	80	13,50
				100	14,84
				120	16,19
				140	17,75
6	7	21	18	80	16,39
				100	19,12
				120	21,92
				140	23,18
				160	24,37
				180	25,95
				200	28,14
240	31,14				

K	L1	d1	D	L	€
6	7	36	30	160	34,53
				200	40,34
				240	44,47
				280	48,61
				300	51,63

## N 15

### Kuulajohde ilman kantaa

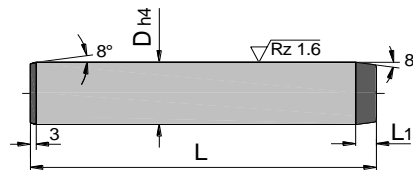

Tilauskoodi:

1 kpl N15 Ø12/80

Erikoismittoja tilauksesta

Raaka-aine: 1.7139 ca. 700HV

L1	D	L	€
4	12	80	12,29
		100	13,10
		125	13,97
7	18	100	15,84
		125	16,84
		140	17,21
		160	18,26
		180	20,49
		200	22,40

L1	D	L	€
7	30	160	25,64
		240	34,85

## N 135

### Kuulakori täydellinen

Tilauskoodi

1 kpl N135 Ø12/35

Erikoismittoja tilauksesta

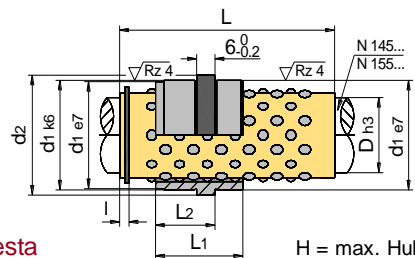

H = max. Hub

l	d1	d2	L1	L2	H	D	L	€
2,5	22	25	26	17	35	12	35	34,22
							48	39,56
							56	45,00
2,8	30	33	34	22	44	18	45	41,23
							56	45,74
							71	47,82

l	d1	d2	L1	L2	H	D	L	€
2,8	38	41	44	27	45	24	50	53,16
							70	55,15
							84	61,64
4,8	46	49	54	32	55	30	32	56,47
							70	70,12
							95	76,08
							110	81,21

## N 1305

### Holkki

Tilauskoodi

1 kpl N1305 Ø17

Erikoismittoja tilauksesta

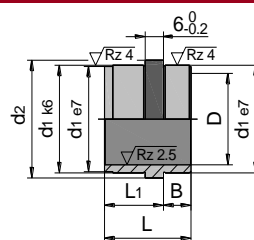

Raaka-aine 1.7139 ca. 700HV

d1	d2	B	L1	L	D	€
22	25	9	17	26	17	9,63
30	33	12	22	34	24	12,97
38	41	17	27	44	30	17,58
46	49	22	32	54	38	20,72

## N 1315

### Kuulakori

Tilauskoodi

1 kpl N1315 Ø12/35

Erikoismittoja tilauksesta

Raaka-aine: messinki

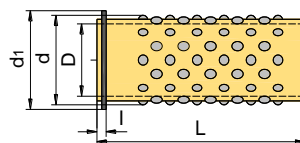

l	d	d1	D	L	€
2,5	17	20,5	12	35	24,59
				48	29,93
				56	35,37
2,8	24	28,6	18	45	28,26
				56	32,75
				71	34,85

l	d	d1	D	L	€
2,8	30	35,7	24	50	35,58
				70	37,57
				84	44,06
4,8	38	43,5	30	56	43,74
				70	49,40
				95	55,36
				110	60,49

## N 145

### Kuulajohdetappi

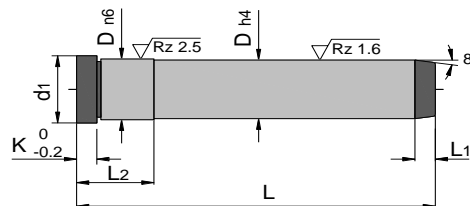

Tilauskoodi

1 kpl N145 Ø12/80

Erikoismittoja tilauksesta

Raaka-aine: 1.7139 ca. 700HV

K	L1	L2	d1	D	L	€
4	4	17	15	12	80	14,23
					100	15,90
					120	16,43
					140	18,21
					160	18,73
6	5	22	21	18	80	17,05
					100	19,46
					120	22,29
					140	23,55
					160	24,69
					180	26,37

K	L1	L2	d1	D	L	€
6	6	27	27	24	100	21,88
					120	24,28
					140	27,11
					160	29,09
					180	31,50
					200	33,90
6	7	36	35	30	140	30,24
					160	34,75
					180	37,68
					200	40,50
					250	46,67

## N 155

### Kuulajohdetappi ilman kantaa

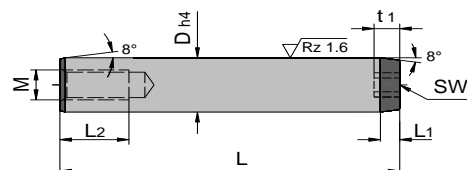

Tilauskoodi

1 kpl N155 Ø12/80

Erikoismittoja tilauksesta

Raaka-aine: 1.7139 ca. 700HV

M	L1	L2	SW	T1	D	L	€
8	4	17	5	5	12	80	12,97
						100	13,82
						120	14,34
						140	15,28
						160	16,95
10	5	20	6	6	18	80	14,65
						100	15,90
						120	16,75
						140	17,79
						160	18,95
					180	21,14	

M	L1	L2	SW	T1	D	L	€
12	6	25	8	8	24	100	17,58
						120	19,25
						140	20,83
						160	22,91
						180	24,81
						200	27,00
16	7	30	8	8	30	140	24,28
						160	26,37
						180	28,78
						200	31,19
						250	37,05

## N 16 Tukitolppa

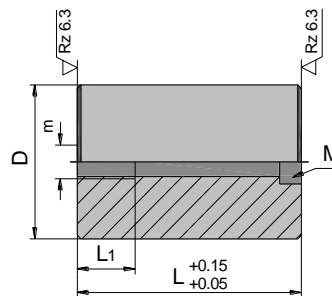

Tilauskoodi

1 kpl N16 Ø32/46

Erikoismittoja tilauksesta

Raaka-aine: 1.7139

M	m	L1	D	L	€
M6	M8	15	32	46	9,13
				56	10,57
				66	11,14
				76	11,67
				86	13,11
				96	14,85
				116	17,48
				136	19,74
M8	M10	20	40	46	12,94
				56	14,29
				66	14,84
				76	15,41
				86	16,12
				96	16,84
				116	18,66
				136	21,49
M8	M10	20	50	46	16,36
				56	16,84
				66	17,30
				76	17,94
				86	18,66
				96	19,37
				116	20,56
				136	22,94
M8	M10	20	60	56	18,58
				66	19,55
				76	20,21
				86	21,41
				96	22,73
				116	25,24
				136	27,86
				156	30,59
176	34,95				

M	m	L1	D	L	€
M8	M10	20	63	56	19,37
				66	19,85
				76	20,56
				86	21,82
				96	23,11
				116	25,64
				136	28,19
				156	30,96
M10	M12	25	70	66	21,53
				76	22,83
				86	24,81
				96	26,11
				116	28,85
				136	32,13
				156	35,51
				176	38,24
M10	M12	25	80	66	22,39
				76	24,30
				86	26,28
				96	28,19
				116	32,23
				136	36,60
				156	40,97
				176	45,33



## N 17

### Jousikorokepala

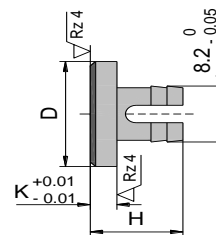

Tilauksoodi:

1 kpl N17 Ø16

Erikoismittoja tilauksesta

Raaka-aine: 1.7139 ca. 490HV

H	K	D	€	
11	3	16	6,19	
12	4	20	7,37	

H	K	D	€	
11	3	25	8,11	
12	4	30	9,72	

## N 18

### Korokepala

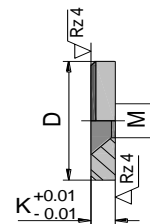

Tilauksoodi:

1 kpl N18 Ø18

Erikoismittoja tilauksesta

Raaka-aine: 1.7139 ca. 980 N/mm<sup>2</sup>

M	K	D	€	
M4	3	18	1,51	
		28	2,46	

M	K	D	€	
M5	4	20	1,75	
		30	2,70	

## N 19

### Ohjausrenkas

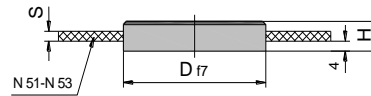

Tilauskoodi:

1 kpl N19 Ø40/6

Erikoismittoja tilauksesta

Raaka-aine: 1.1191

S	D	H	€		S	D	H	€	
-	40	6	5,16		-	125	8	17,87	
3		9	5,72		-		12	19,37	
-	60	8	8,41		6		18	20,24	
3		11	8,82		8		20	21,07	
5		13	9,28		8,5		21	21,36	
-	80	8	11,90		-	130	12	19,93	
3		15	12,54		-		140	12	21,12
5		17	13,02		-	150	12	23,44	
-	90	12	14,45		8,5		21	24,49	
3		15	15,16		-		160	8	23,18
5		17	16,99		-	12		25,80	
6		18	17,87		6	20		26,76	
7		19	18,74		8	22		28,25	
8,5	21	20,10		8,5	23	28,74			
-	100	8	16,04		-	175	12	27,15	
-		12	16,28		8,5		21	29,06	
6		18	19,46		-	200	12	32,78	
8,5		21	20,41		5		20	37,47	
-	110	12	16,99		8		22	39,27	
6		18	19,88		8,5		23	40,34	
8,5		21	20,72		-	250	12	45,89	
-	120	12	17,47		8		22	49,31	
8,5		21	21,03		8,5		23	49,62	

## N 20

### Ohjausrengas

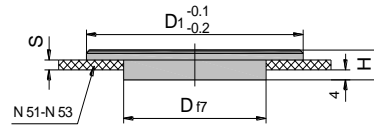

Tilaukoodi:

1 kpl N20 Ø60/8

Erikoismittoja tilauksesta

Raaka-aine: 1.1191

S	D	D1	H	€
-	90	60	8	17,06
3			11	17,78
5			13	18,34
6			14	18,73
-	90	80	12	17,06
3			15	17,78
5			17	18,34
-	90	100	8	17,22
-			12	17,47
3			15	18,18
5			17	18,98
6			18	19,50
7			19	20,00
8,5		21	21,12	
-	90	110	12	18,90
3			15	19,93
5			17	20,64
6			18	21,28
7			19	21,92
8			20	22,55
8,5		21	23,18	
-	90	120	12	20,00
3			15	21,12
5			17	21,92
6			18	22,47
7			19	23,02
8			20	23,62
8,5			21	24,21

S	D	D1	H	€
-	90	125	12	20,81
3			15	22,14
5			17	23,11
6			18	23,62
7			19	24,14
8			20	24,89
8,5			21	25,64
-	90	140	12	25,40
-	90	150	12	29,06
-	90	160	12	33,19
3			15	34,85
5			17	36,92
6			18	37,80
7			19	38,66
8			20	39,98
8,5			21	41,28
-	90	175	12	35,17
3			15	37,47
5			17	39,54
6			18	40,85
7			19	42,16
8			20	43,32
8,5		21	44,47	
-	90	200	12	53,99
-	90	250	12	65,59

## N 21

### Ohjausrengas

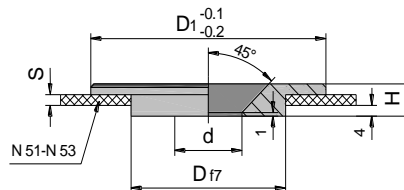

Tilauskoodi:

1 kpl N21 Ø60/8

Erikoismittoja tilauksesta

Raaka-aine: 1.1191

S	d	D	D1	H	€	
-	36	90	60	8	18,90	
3	26			11	20,09	
5	26			13	20,72	
6	26			14	21,14	
-	36	90	80	12	18,90	
3	26			15	20,09	
5	26			17	20,72	
-	36	90	90	12	19,21	
3				15	20,39	
5				17	21,12	
6				18	21,67	
7				19	22,24	
8,5				21	24,30	
-	36	90	100	8	19,37	
-				12	19,61	
3				15	20,72	
5				17	22,24	
6				18	22,90	
7				19	23,58	
8,5				21	25,01	
-	36	90	110	12	20,72	
3				15	22,55	
5				17	23,98	
6				18	24,79	
7				19	25,57	
8				20	26,36	
8,5				21	27,15	
-	36	90		120	12	21,92
3			15		23,74	
5			17		25,08	
6			18		25,83	
7			19		26,59	
8			20		27,40	
8,5			21		28,19	

S	d	D	D1	H	€
-	36	90	125	12	22,79
3				15	24,54
5				17	26,20
6				18	27,00
7				19	27,79
8				20	28,70
8,5				21	29,62
-	36	90	130	12	28,02
-	36	90	140	12	30,81
-	36	90	150	12	35,17
-	36	90	160	12	36,21
3				15	37,47
5				17	39,78
6				18	41,10
7				19	42,41
8				20	43,86
8,5				21	45,33
-	36	90	175	12	37,16
3				15	40,09
5				17	42,72
6				18	44,31
7				19	45,89
8				20	47,20
8,5			21	48,51	
-	36	90	180	12	49,70
-	36	90	200	12	56,38
-	36	90	250	12	68,60

## N 30

Avosuutin ilman sädettä

$\alpha = 0,5^\circ / 1,0^\circ / 1,5^\circ$

Tilauskoodi:

1 kpl N30 Ø12/22/2.5/0,5°

Erikoismittoja tilauksesta

Raaka-aine: 1.2826 ca. 580HV

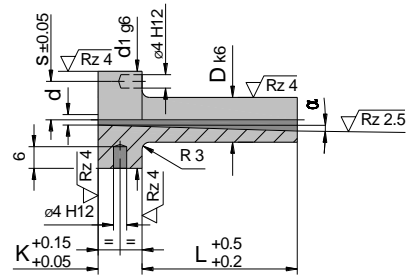

$\alpha$	s	K	d1	D	L	d	€
0,5°	11	13	28	12	22	2,5	32,15
					27		32,64
					36		33,35
					46		35,33
					56		40,81
0,5°	11	13	28	12	27	3,5	32,64
					36		33,35
					46		35,33
					56		40,81
					66		45,65
0,5°	15	18	38	18	46	3	42,09
					56		47,00
					66		51,30
					76		55,57
					86		59,47
0,5°	15	18	38	18	46	4	42,09
					56		47,00
					66		51,30
					76		55,57
					86		59,47

$\alpha$	s	K	d1	D	L	d	€
1°	15	18	38	18	27	3	35,33
					36		38,18
					46		42,09
					56		47,00
					66		51,30
1°	15	18	38	18	27	4	35,33
					36		38,18
					46		42,09
					56		47,00
					66		51,30
1°	20	23	48	24	46	5	53,03
					56		58,91
					66		62,80
					76		66,61
					86		70,98
1°	20	23	48	24	46	5	53,03
					56		58,91
					66		62,80
					76		66,61
					86		70,98

$\alpha$	s	K	d1	D	L	d	€
1°	11	13	28	12	22	2,5	32,07
					27		32,64
					36		33,35
					46		35,33
					56		40,81
1°	11	13	28	12	22	3	32,07
					27		32,64
					36		33,35
					46		35,33
					56		40,81
1°	11	13	28	12	22	3,5	32,07
					27		32,64
					36		33,35
					46		35,33
					56		40,81

$\alpha$	s	K	d1	D	L	d	€
1,5°	15	18	38	18	27	3,5	35,33
					36		38,18
					46		42,09
					56		47,00
					66		51,30
1,5°	15	18	38	18	27	4,5	35,33
					36		38,18
					46		42,09
					56		47,00
					66		51,30
1,5°	20	23	48	24	46	4,5	53,03
					56		58,91
					66		62,80
					76		66,61
					86		70,98
1,5°	20	23	48	24	46	6,5	53,03
					56		58,91
					66		62,80
					76		66,61
					86		70,98

## N 31

Avosuutin 15,5 säteellä

$\alpha = 0,5^\circ / 1,0^\circ / 1,5^\circ$

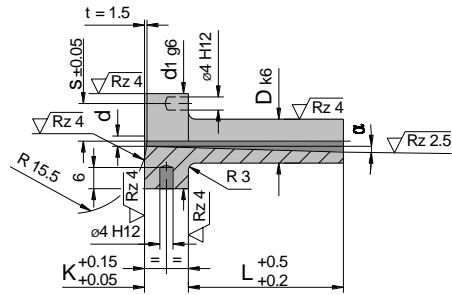

Tilaukskoodi:

1 kpl N31 Ø12/27/2.5/0,5°

Erikoismittoja tilauksesta

Raaka-aine: 1.2826 ca. 580HV

$\alpha$	s	K	d1	D	L	d	€
0,5°	11	13	28	12	27	2,5	34,70
							35,33
							37,23
							42,80
0,5°	11	13	28	12	27	3,5	34,70
							35,33
							37,23
							42,80
							47,64
							52,50
0,5°	15	18	38	18	46	3	44,06
							48,90
							53,27
							57,64
							61,61
							65,66
0,5°	15	18	38	18	46	4	44,06
							48,90
							53,27
							57,64
							61,61
							65,66

$\alpha$	s	K	d1	D	L	d	€
1°	15	18	38	18	27	3	37,23
							40,25
							44,06
							48,90
							53,27
							57,64
1°	15	18	38	18	27	4	37,23
							40,25
							44,06
							48,90
							53,27
							57,64
1°	20	23	48	24	46	5	55,02
							60,97
							64,78
							68,60
							73,05
							77,41
1°	20	23	48	24	46	5	55,02
							60,97
							64,78
							68,60
							73,05
							77,41
1°	20	23	48	24	46	5	55,02
							60,97
							64,78
							68,60
							73,05
							77,41
1°	20	23	48	24	46	5	55,02
							60,97
							64,78
							68,60
							73,05
							77,41
1°	20	23	48	24	46	5	55,02
							60,97
							64,78
							68,60
							73,05
							77,41
1°	20	23	48	24	46	5	55,02
							60,97
							64,78
							68,60
							73,05
							77,41
1°	20	23	48	24	46	5	55,02
							60,97
							64,78
							68,60
							73,05
							77,41
1°	20	23	48	24	46	5	55,02
							60,97
							64,78
							68,60
							73,05
							77,41
1°	20	23	48	24	46	5	55,02
							60,97
							64,78
							68,60
							73,05
							77,41
1°	20	23	48	24	46	5	55,02
							60,97
							64,78
							68,60
							73,05
							77,41
1°	20	23	48	24	46	5	55,02
							60,97
							64,78
							68,60
							73,05
							77,41
1°	20	23	48	24	46	5	55,02
							60,97
							64,78
							68,60
							73,05
							77,41
1°	20	23	48	24	46	5	55,02
							60,97
							64,78
							68,60
							73,05
							77,41
1°	20	23	48	24	46	5	55,02
							60,97
							64,78
							68,60
							73,05
							77,41
1°	20	23	48	24	46	5	55,02
							60,97
							64,78
							68,60
							73,05
							77,41
1°	20	23	48	24	46	5	55,02
							60,97
							64,78
							68,60
							73,05
							77,41
1°	20	23	48	24	46	5	55,02
							60,97
							64,78
							68,60
							73,05
							77,41
1°	20	23	48	24	46	5	55,02
							60,97
							64,78
							68,60
							73,05
							77,41
1°	20	23	48	24	46	5	55,02
							60,97
							64,78
							68,60
							73,05
							77,41
1°	20	23	48	24	46	5	55,02
							60,97
							64,78
							68,60
							73,05
							77,41
1°	20	23	48	24	46	5	55,02
							60,97
							64,78
							68,60
							73,05
							77,41
1°	20	23	48	24	46	5	55,02
							60,97
							64,78
							68,60
							73,05
							77,41
1°	20	23	48	24	46	5	55,02
							60,97
							64,78
							68,60
							73,05
							77,41
1°	20	23	48	24	46	5	55,02
							60,97
							64,78
							68,60
							73,05
							77,41
1°	20	23	48	24	46	5	55,02
							60,97
							64,78
							68,60
							73,05
							77,41
1°	20	23	48	24	46	5	55,02
							60,97
							64,78
							68,60
							73,05
							77,41
1°	20	23	48	24	46	5	55,02
							60,97
							64,78
							68,60
							73,05
							77,41
1°	20	23	48	24	46	5	55,02
							60,97
							64,78
							68,60
							73,05
							77,41
1°	20	23	48	24	46	5	55,02
							60,97
							64,78
							68,60
							73,05
							77,41
1°	20	23	48	24	46	5	55,02
							60,97
							64,78
							68,60
							73,05
							77,41
1°	20	23	48	24	46	5	55,02
							60,97
							64,78
							68,60
							73,05
							77,41
1°	20	23	48	24	46	5	55,02
							60,97
							64,78
							68,60
							73,05
							77,41
1°	20	23	48	24	46	5	55,02
							60,97
							64,78
							68,60
							73,05
							77,41
1°	20	23	48	24	46	5	55,02
							60,97
							64,78
							68,60
							73,05
							77,41
1°	20	23	48	24	46	5	55,02
							60,97
							64,78
							68,60
							73,05
							77,41
1°	20	23	48	24	46	5	55,02
							60,97
							64,78
							68,60
							73,05
							77,41
1°	20	23	48	24	46	5	55,02
							60,97
							64,78
							68,60
							73,05
							77,41
1°	20	23	48	24	46	5	55,02
							60,97
							64,78
							68,60
							73,05
							77,41
1°	20	23	48	24	46	5	55,02
							60,97
							64,78
							68,60
							73,05
							77,41
1°	20	23	48	24	46	5	55,02
							60,97
							64,78
							68,60
							73,05
							77,41
1°	20	23	48	24	46	5	55,02
							60,97
							64,78
							68,60
							73,05
							77,41
1°	20	23	48	24	46	5	55,02
							60,97
							64,78
							68,60
							73,05
							77,41
1°	20	23	48	24	46	5	55,02
							60,97
							64,78
							68,60
							73,05
							77,41
1°	20	23	48	24	46	5	55,02
							60,97
							64,78
							68,60
							73,05
							77,41
1°	20	23	48	24	46	5	55,02
							60,97
							64,78
							68,60
							73,05
							77,41
1°	20	23	48	24	46	5	55,02
							60,97
							64,78
							68,60
							73,05
							77,41
1°	20	23	48	24	46	5	55,02
							60,97
							64,78
							68,60
							73,05
							77,41
1°	20	23	48	24	46	5	55,02
							60,97
							64,78
							68,60
							73,05
							77,41
1°	20	23	48	24	46	5	55,02
							60,97
							64,78
							68,60
							73,05
							77,41
1°	20	23	48	24	46	5	55,02
							60,97
							64,78
							68,60
							73,05
							77,41
1°	20	23	48	24	46	5	55,02
							60,97
							64,78
							68,60
							73,05
							77,41
1°	20	23	48	24	46	5	55,02
							60,97
							64,78
							68,60
							73,05
							77,41
1°	20	23	48	24	46	5	55,02
							60,97
							64,78
							68,60
							73,05
							77,41
1°	20	23	48	24	46	5	55,02
							60,97
							64,78
							68,60
							73,05
							77,41
1°	20	23	48	24	46	5	55,02
							60,97
							64,78
							68,60
							73,05
							77,41
1°	20	23	48	24	46	5	55,02
							60,97
							64,78
							68,60
							73,05
							77,41
1°	20	23	48	24	46	5	55,02
							60,97
							64,78
							68,60
							73,05
							77,41
1°							

## N 32

Avosuutin 40 säteellä

$\alpha = 0,5^\circ / 1,0^\circ / 1,5^\circ$

Tilauskoodi:

1 kpl N32 Ø12/27/2.5/0,5°

Erikoismittoja tilauksesta

Raaka-aine: 1.2826 ca. 580HV

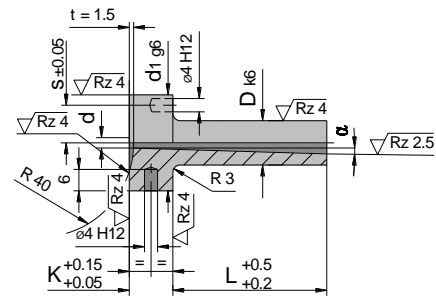

$\alpha$	s	K	d1	D	L	d	€
0,5°	11	13	28	12	27	2,5	34,70
					36		35,33
					46		37,23
					56		42,80
0,5°	11	13	28	12	27	3,5	34,70
					36		35,33
					46		37,23
					56		42,80
					66		47,64
					76		52,50
0,5°	15	18	38	18	46	3	44,06
					56		48,90
					66		53,27
					76		57,64
					86		61,61
					96		65,66
0,5°	15	18	38	18	46	4	44,06
					56		48,90
					66		53,27
					76		57,64
					86		61,61
					96		65,66

$\alpha$	s	K	d1	D	L	d	€						
1°	15	18	38	18	27	3	37,23						
					36		40,25						
					46		44,06						
					56		48,90						
					66		53,27						
					76		57,64						
1°	15	18	38	18	27	4	37,23						
					36		40,25						
					46		44,06						
					56		48,90						
					66		53,27						
					76		57,64						
1°	15	18	38	18	86	4	61,61						
					96		65,66						
					116		75,02						
					136		97,19						
					1°		20	23	48	24	46	5	55,02
											56		60,97
66	64,78												
76	68,60												
86	73,05												
96	77,41												

$\alpha$	s	K	d1	D	L	d	€
1°	11	13	28	12	22	2,5	34,07
					27		34,70
					36		35,33
					46		37,23
					56		42,80
1°	11	13	28	12	22	3	34,07
					27		34,70
					36		35,33
					46		37,23
					56		42,80
1°	11	13	28	12	22	3,5	34,07
					27		34,70
					36		35,33
					46		37,23
					56		42,80

$\alpha$	s	K	d1	D	L	d	€
1,5°	15	18	38	18	27	3,5	37,23
					36		40,25
					46		44,06
					56		48,90
1,5°	15	18	38	18	27	4,5	37,23
					36		40,25
					46		44,06
					56		48,90
1,5°	15	18	38	18	76	4,5	57,64
					86		61,61
					96		65,66
					116		75,02
1,5°	20	23	48	24	46	4,5	55,02
					56		60,97
					66		64,78
					76		68,60
1,5°	20	23	48	24	56	6,5	60,97
					66		64,78
					76		68,60
					86		73,05



## N 40 Palautinholkki

Tilauskoodi:

1 kpl N40 Ø12/22

Erikoismittoja tilauksesta

Raaka-aine: 1.2826 ca. 580HV

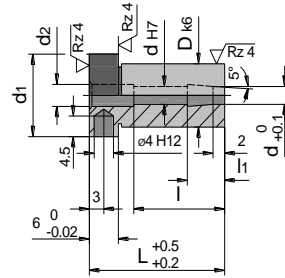

l1	l	d2	d1	d	D	L	€
7	18	4,5	16	4	12	22	14,22
						27	14,93
						36	15,87
						46	17,87
						56	20,24
7	27	6,5	22	6	18	22	15,87
						27	16,52
						36	17,16
						46	18,49
						56	19,53
						66	20,88
9,5	28	8,5	28	8	24	76	22,63
						36	18,49
						46	19,77
						56	21,68
						66	24,06
					76	26,51	
					86	28,90	
					96	31,35	



TXG Messinkiholkki ilman  
peräohjausta,  
grafiittivoitelu

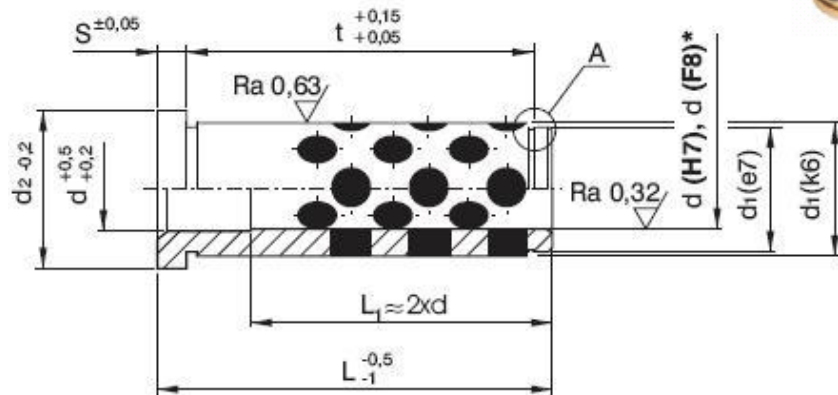

d	d <sub>1</sub>	d <sub>2</sub>	s	t	L
9/10	14	16	3	6,6	12
				11,6	17
				16,6	22
				21,6	27
				30,6	36
				40,6	46
				50,6	56
12	18	23	6	8,3	17
				13,3	22
				18,3	27
				27,3	36
				37,3	46
				47,3	56
14/15	20	25	6	8,3	17
				13,3	22
				18,3	27
				27,3	36
				37,3	46
				47,3	56
16	22	27	6	13,3	22
				18,3	27
				27,3	36
				37,3	46
				47,3	56
18/20	26	31	6	8,3	17
				13,3	22
				18,3	27
				27,3	36
				37,3	46
				47,3	56

d	d <sub>1</sub>	d <sub>2</sub>	s	Z	t	L
18/20	26	31	6		47,3	56
					57,3	66
					67,3	76
22/24	30	35	6		12,6	22
					17,6	27
					26,6	36
					36,6	46
					46,6	56
					56,6	66
30/32	42	47	6		15,9	27
					24,9	36
					34,9	46
					44,9	56
					54,9	66
					64,9	76
40/42	54	60	10		74,9	86
					84,9	96
					104,9	116
					30,2	46
					40,2	56
					50,2	66
					60,2	76
					70,2	86
					80,2	96
					100,2	116
					120,2	136



## TPG Messinkiholkki peräohjauksella, grafiittivoideltu

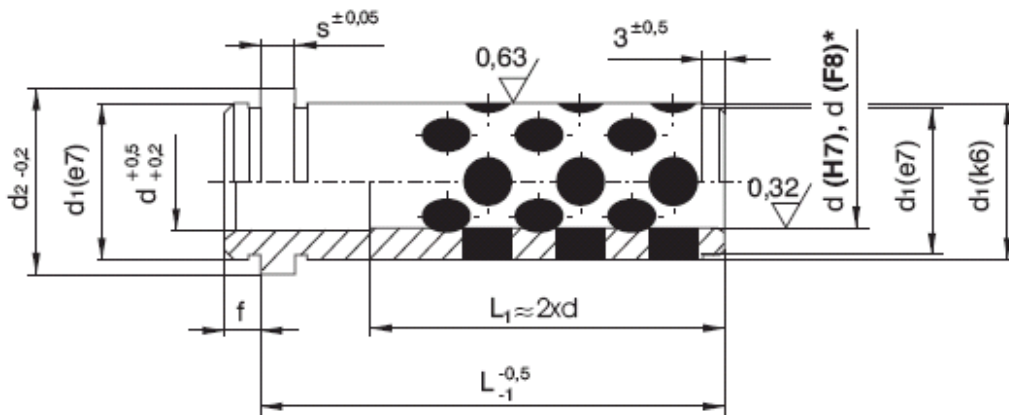

d	d <sub>1</sub>	d <sub>2</sub>	s	f	L
9/10	14	16	3	3	12
					17
					22
					27
					36
					46
					56
14/15	20	25	6	6	17
					22
					27
					36
					46
					56
					66
76					
18/20	26	31	6	8	17
					22
					27
					36
					46
					56
					66
76					
22/24	30	35	6	8	22
					27
					36
					46

d	d <sub>1</sub>	d <sub>2</sub>	s	f	L
22/24	30	35	6	8	56
					66
					76
					86
					96
					116
30/32	42	47	6	8	27
					36
					46
					56
					66
					76
40/42	54	60	10	12	46
					56
					66
					76
					86
					96
22/24	30	35	6	8	136
					156
					196

## Vinotapin pidin, VP

Raaka-aine 2312

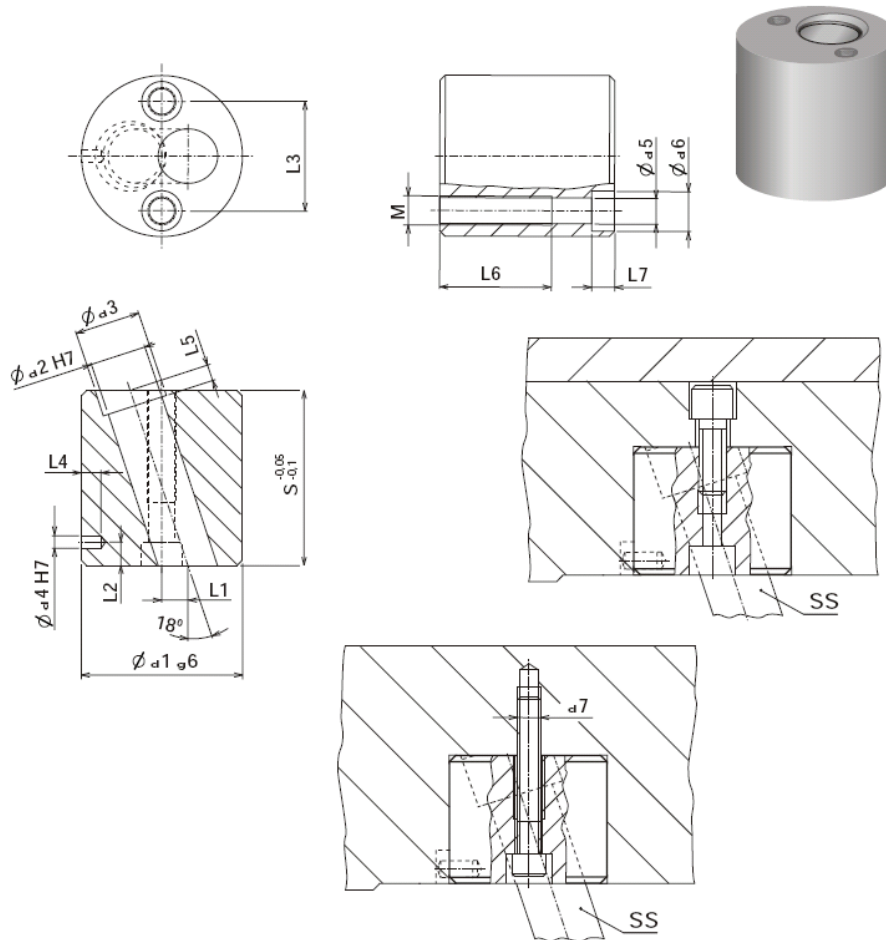

d1	d2	S	d3	d4	d5	d6	M	d7	L1	L2	L3	L4	L5	L6	L7
32	10	27	13	4	5,2	9	M6	M5	4,5	4	21	6	3	15	5,5
36	12	36	17						6						
	14			19										8	
42	16	46	21	5	6,8	11	M8	M6	8	6	29	8		20	8,5
48	18		23						8,5						
	20		25	6								10			
54	22	66	27		8,5	13,5	M10	M8	11		36		15	20	10,5
	24		29												
60	30		37	8						8	44,5	12			



## SIVULIIKKUVA, SL

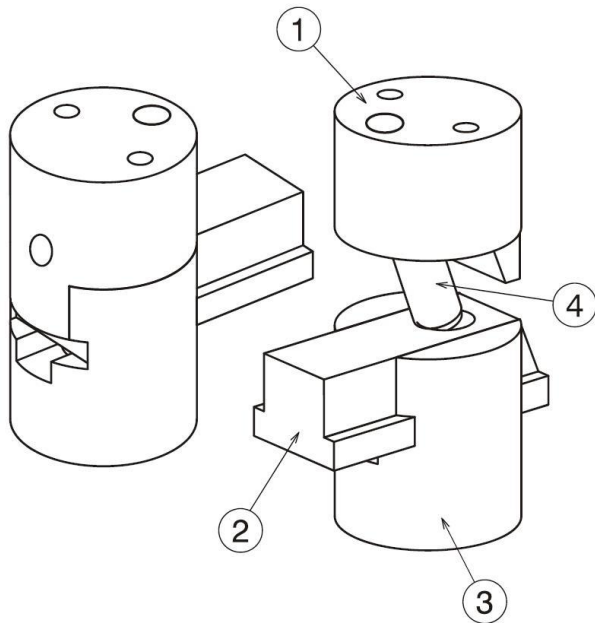

OSA	Raaka-aine	Käsittely
1	1.2312	Nitrattu
2	1.2343	Karkaistu HRC 52-54
3	1.2312	Nitrattu
4	C53	Karkaistu HRC 52-54

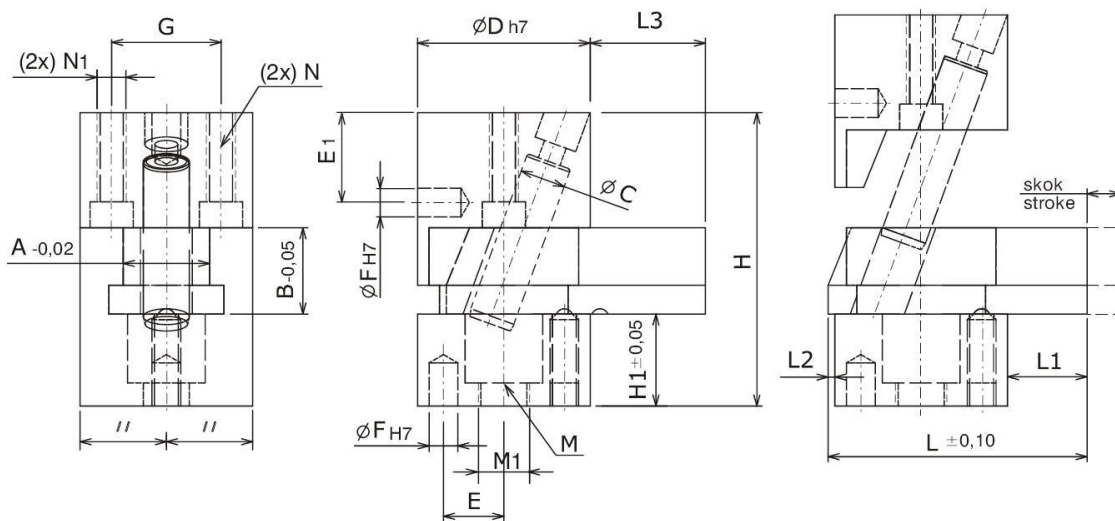

Koodi	A	B	C	D	E	E1	F	G	H	H1	L	L1	L2	L3	M	M1	N	N1	isku
SL-22	10	10	Ø6	Ø22	7,5	11,5	Ø4H7	14	34,5	10	35	12,5	0,5	15	M4	M5	M3	M4	2,5
SL-30	15	15	Ø8	Ø30	10,5	15,5	Ø5H7	19	51	16	45	15,4	-	20	M6	M8	M4	M5	4,6
SL-35	20	20	Ø10	Ø35	13	15,5	Ø5H7	24	63	23	55,5	17,8	2,7	25	M8	M10	M5	M6	7,2

## Nollaohjuri

Raaka-aine: 1.2343

Kovuus: 50-56 HRC

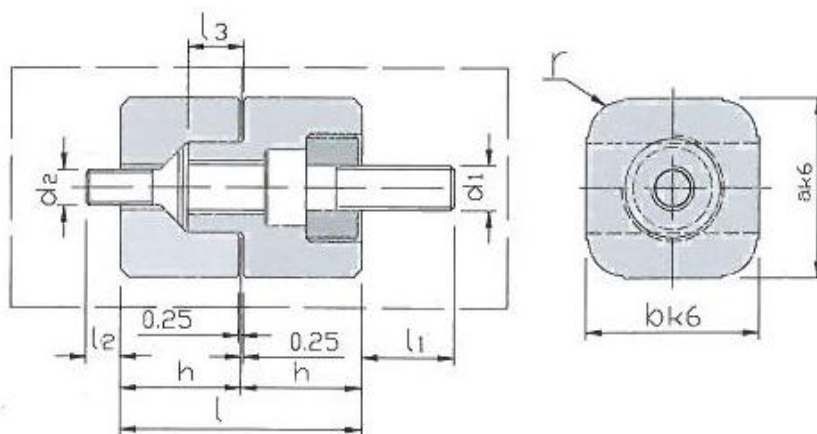

Typpi	Mitta									
	r	d <sub>1</sub>	d <sub>2</sub>	l <sub>1</sub>	l <sub>2</sub>	l <sub>3</sub>	l	h	a	b
<b>Z08/20 X 20 N</b>	4	M5	M4	12	4	3.5	28	14	<b>20</b>	<b>20</b>
<b>Z08/25X25 N</b>	5	M6	M5	13	8	5.5	32	16	<b>25</b>	<b>25</b>
<b>Z08/32 x 32 N</b>	6	M8	M6	15	12	7.5	36	18	<b>32</b>	<b>32</b>
<b>Z08/40 X 40 N</b>		M10	M8	17	10	9.5	45	22.5	<b>40</b>	<b>40</b>